

SCM SLIM CANOPY

DESCRIPTION

naturaLED® SCM is ETL for wet locations with a rating of IP65. Aesthetically pleasing construction, low-profile design with die-cast aluminum housing and shatter-resistant polycarbonate prismatic lens. Dustproof, sealed structure, 1/2" threaded conduit entrances on each side. This fixture comes with or without an integral microwave occupancy sensor, factory mounted behind the lens. The microwave occupancy sensor has multiple sensor settings that can be selected via dip switch at the sensor brain inside the fixture which include: daylight sensing, step-dimming, area sensitivity, standby time and on/off. The canopy supports both pendant mounting and direct surface mounting ceiling and wall. The fixture can be Pendant Mounted and accepts a 3/4" NPT thread and can be mounted to multiple types of J-boxes.

APPLICATIONS

Warehouses, Parking Garages, Offices, Factories, Hospitals, Hotels

FEATURES

- DLC Premium
- IP65 Rated
- ETL Listed
- ColorTemp: 4000K, 5000K
- Voltage: 120-277V
- Powerfactor >0.9
- Surge Protection: 2KV
- Beam Angle: 160°
- Dimmable: 1-10V
- CRI: >70
- Operating temperature: - 22°F - 131°F
- Multiple Sensor Settings
- Material: aluminum die-cast
- Shatter-resistant Polycarbonate Lens
- Colors: Black /White
- 5 Year Warranty
- Optional for Purchase: Drop Lens, Frosted Lens, Beauty Plates

PROJECT: _____

SCHEDULE: _____ DATE: _____

PREPARE BY: _____

NOTES: _____



ACCESSORIES

	Beauty Plate
	Drop Lens
	Frosted Lens
	Motion Sensor

SAMPLE NUMBER		LED-FXSCM70/50K/BK-SEN				
STYLE	FAMILY	SERIES	WATTAGE	CRI/COLOR TEMP	COLOR	ACCESSORY
LED	FX	SCM	70	50K	BK	SEN
LED Lighting	Fixture	Slim Canopy	70 Watt	5000K	Black (WH) White	(SEN) Motion Sensor none N/A



ORDERING

*P= Premium DLC / *S = Standard DLC

Watts (W)	Ordering Code	Description	CCT (K)	Lumens (Lm)	Dim (V)	Color	Sensor	IP65 Rated	DLC (S/P)
42	7471	LED-FXSCM42/50K/BK	5000K	4,682	1-10V	Black	-	•	-
59	7473	LED-FXSCM59/50K/BK	5000K	7,910	1-10V	Black	-	•	P
42	7498	LED-FXSCM42/50K/WH	5000K	4,682	1-10V	White	-	•	-
59	7499	LED-FXSCM59/40K/WH	4000K	7,795	1-10V	White	-	•	P
28	7480	LED-FXSCM28/50K/WH-SEN	5000K	3,606	1-10V	White	•	•	-
70	7564	LED-FXSCM70/50K/BK-SEN	5000K	5,900	1-10V	Black	•	•	-
45	7561	LED-FXSCM45/50K/WH-SEN	5000K	4,150	1-10V	White	•	•	-
70	7565	LED-FXSCM70/50K/WH-SEN	5000K	5,900	1-10V	White	•	•	-

ACCESSORIES (Ordered Separately)

Drop Lens



P10126 LENS-SCM/DR9X9
(Drop Lens for SCM 28W, 42W, 59W)

Motion Sensor



P10234 SEN-MC605V-D
(Microwave Motion Photocell Sensor 0-10V)

Frosted Lens



P10125 LENS-SCM/FR9X9
(Frosted Lens for SCM 28W, 42W, 59W)

Beauty Plates



P10195 PLT-SCM/14X14/WH
(14"x14" Beauty Plate used with SCM)

P10196 PLT-SCM/24X24/WH
(24"x24" Beauty Plate used with SCM)

DIMENSIONS

28W 42W 59W
4.50-lbs 5.10-lbs 5.10-lbs

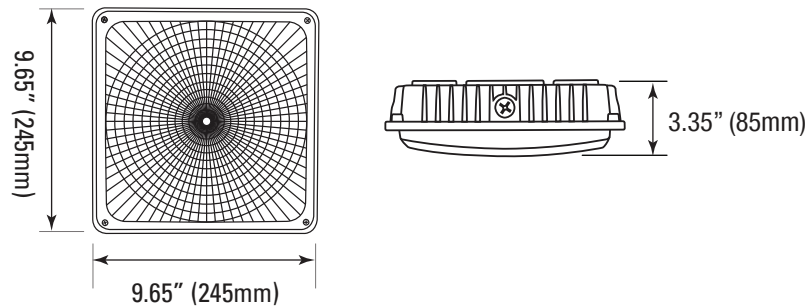

PHOTOMETRICS CHART

28 Watt
Slim Lens

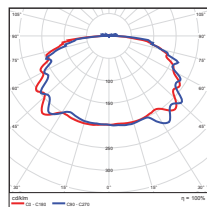

Illuminance at a Distance Center Beam (f) Beam Width			
5.0ft	25.7 fc	40.7 ft	95.4 ft
10.0ft	6.42 fc	81.4 ft	180.8 ft
15.0ft	2.85 fc	122.1 ft	118.2 ft
20.0ft	1.61 fc	162.8 ft	157.6 ft
25.0ft	1.03 fc	203.5 ft	197.0 ft
30.0ft	0.71 fc	244.3 ft	236.4 ft

Vert. Spread: 102.4°
Horiz. Spread: 131.3°

42 Watt
Slim Lens

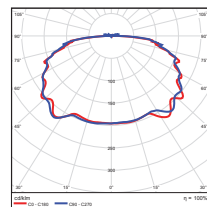

Illuminance at a Distance Center Beam (f) Beam Width			
5.0ft	36.1 fc	36.1 ft	82.9 ft
10.0ft	9.03 fc	72.2 ft	165.8 ft
15.0ft	4.23 fc	108.3 ft	158.8 ft
20.0ft	2.38 fc	144.4 ft	211.5 ft
25.0ft	1.52 fc	180.5 ft	254.4 ft
30.0ft	1.06 fc	216.6 ft	317.3 ft

Vert. Spread: 149.0°
Horiz. Spread: 158.6°

59 Watt
Slim Lens

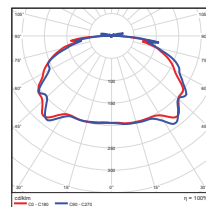

Illuminance at a Distance Center Beam (f) Beam Width			
5.0ft	82.9 fc	27.6 ft	85.7 ft
10.0ft	20.7 fc	55.2 ft	165.4 ft
15.0ft	8.97 fc	82.8 ft	98.1 ft
20.0ft	5.30 fc	110.4 ft	130.9 ft
25.0ft	3.38 fc	138.0 ft	163.6 ft
30.0ft	2.41 fc	165.6 ft	196.3 ft

Vert. Spread: 142.2°
Horiz. Spread: 146.0°

28 Watt
Tall Lens

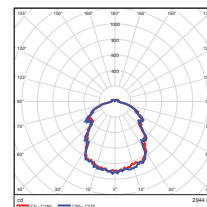

Illuminance at a Distance Center Beam (f) Beam Width			
5.0ft	35.9 fc	16.1 ft	16.0 ft
10.0ft	8.97 fc	32.2 ft	32.0 ft
15.0ft	3.99 fc	48.3 ft	30.0 ft
20.0ft	2.24 fc	64.4 ft	40.0 ft
25.0ft	1.43 fc	80.5 ft	50.0 ft
30.0ft	1.00 fc	96.7 ft	60.0 ft

Vert. Spread: 90.0°
Horiz. Spread: 90.0°

42 Watt
Tall Lens

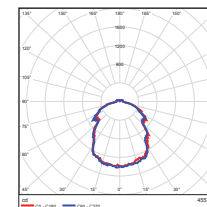

Illuminance at a Distance Center Beam (f) Beam Width			
5.0ft	55.4 fc	16.2 ft	16.1 ft
10.0ft	13.9 fc	32.4 ft	20.1 ft
15.0ft	6.16 fc	48.7 ft	30.2 ft
20.0ft	3.47 fc	65.0 ft	40.2 ft
25.0ft	2.22 fc	81.3 ft	50.3 ft
30.0ft	1.54 fc	97.6 ft	60.3 ft

Vert. Spread: 91.2°
Horiz. Spread: 90.3°

59 Watt
Tall Lens

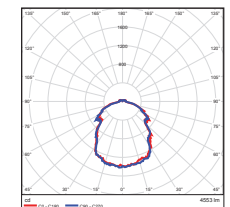

Illuminance at a Distance Center Beam (f) Beam Width			
5.0ft	74.6 fc	9.0 ft	9.0 ft
10.0ft	18.6 fc	18.0 ft	18.0 ft
15.0ft	8.29 fc	27.0 ft	27.0 ft
20.0ft	4.66 fc	36.0 ft	36.0 ft
25.0ft	2.98 fc	45.0 ft	45.0 ft
30.0ft	2.07 fc	54.0 ft	54.0 ft

Vert. Spread: 89.1°
Horiz. Spread: 89.1°

PACKAGE

Case Qty 1 pc

