

CWP CUT-OFF WALL PACK CCT3

PROJECT: _____

SCHEDULE: _____ DATE: _____

PREPARE BY: _____

NOTES: _____

DESCRIPTION

naturaLED® cut-off wallpack comes in rugged cast-aluminum housing with excellent thermal design. Our CWP product offers a popular but classic appearance with sleek angle design. Delivering up to 16,776 lumens with different wattages options: 40W, 60W, 80W, 120W, and 120W selectable wattages and color temperature. Replacing up to 750-watt metal halide luminaires and provides energy saving up to 72%. Our CWP is ideal for outdoor applications such as car ports, loading areas, driveways, parking areas, and pathways. Suggested for wall mounting minimum above four feet from ground.



Photocell Included

Rated Life 50,000 Hours
Warranty 5 Years

APPLICATIONS

Security, Pathway, Perimeter, Entryway, Area Lighting, and Building Facades

FEATURES

- DLC Premium Qualified
- IP65 Rated
- UL/cUL Listed
- Selectable Wattages (60SW/120SW)
- ColorTemp: 4000K, 5000K, CCT3 (60SW/120SW)
- Voltage: 120-277V
- Power Factor: >0.9
- Surge Protection: 4KV (40W/60W/60SW) / 6KV (80W/120W/120SW)
- Beam Angle: Cut-off
- Dimmable: 0-10V
- CRI: >70
- Operating temperature: - 40°F - 122°F
- Uniform and consistent color
- 10-30 foot height performance
- Material: Die Cast Aluminum
- Color: Bronze
- 5Year Warranty
- Optional Accessories for Purchase: Microwave Sensor, Emergency Drivers, Remote Programmer

ACCESSORIES

- Microwave Sensor Kit
- Emergency Drivers
- Remote Programmer

SAMPLE NUMBER LED-FXCWP40/40K/BZ

STYLE	FAMILY	SERIES	WATTAGE	COLOR TEMP	FINISH COLOR
LED	FX	CWP	40	40K	BZ
LED Lighting	Fixture	Cutoff Wall Pack	<40 Watt	4000K	Bronze



CUT-OFF WALL PACK

WALL & AREA LUMINAIRES

ORDERING

*P= Premium DLC / *S = Standard DLC

Watts (W)	Ordering Code	Description	CCT (K)	Lumens (Lm)	Equiv. Wattage (W)	PhotoCell	IP65 Rated	DLC (S/P)
39	9319	LED-FXCWP40/40K/BZ*	4000K	5,288	250	•	•	P
39	9320	LED-FXCWP40/50K/BZ*	5000K	5,356	250	•	•	P
63	9208	LED-FXCWP60/40K/BZ*	4000K	8,347	400	•	•	P
63	9209	LED-FXCWP60/50K/BZ*	5000K	8,425	400	•	•	P
83	9443	LED-FXCWP80/40K/BZ	4000K	11,048	400-575	•	•	P
83	9444	LED-FXCWP80/50K/BZ	5000K	11,193	400-575	•	•	P
121	9445	LED-FXCWP120/40K/BZ	4000K	16,525	575-750	•	•	P
28	9553	FXCWP60SW/CCT3/BZ-PHO	3CCT	3,780	100-250	•	•	P
40			(30/40/50K)	5,400				
60				8,176				
80	9554	FXCWP120SW/CCT3/BZ-PHO	3CCT	10,388	575-750	•	•	P
100			(30/40/50K)	12,985				
126				16,464				

*Motion Sensor Kit
K540380 SEN-ANT-11-WH/BA12V

ACCESSORIES (Ordered Separately)

Emergency Driver



7336 BAEM4-60BC/MV-A
(4W CEC Compliant LED Emergency Driver for #9319, 9320, #9553)



7334 BAEM15-48BC/MV-A
(15W CEC Compliant LED Emergency Driver for #9208, 9209)



7341 BAEM15-260BC/347-A
(15W CEC Compliant LED Emergency Driver 120-347V for #9443, 9444, 9445, 9554)

Microwave Sensor / Remote Programmer



K540380 SEN-ANT-11-WH/BA12V
(Microwave Sensor Kit 0-10V for #9319, 9320, 9208, 9209, 9446)



P10540 SEN-ANT-11-WH
(Remote Programmable Microwave Motion Sensor 0-10V Bi-Level Internal 12V Low Voltage for #9443, 9444, 9445, 9553, 9554)



P10316 SEN-BRI-RC100
(Remote Programmer)

DIMENSIONS

28/40/60W
CCT3
7.05-lbs

39W
6.85-lbs

63W
7.05-lbs

83W
7.48-lbs

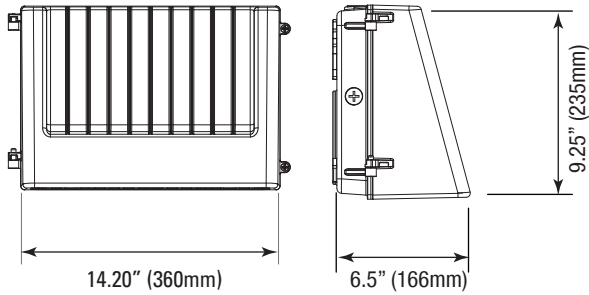

80/100/126W
CCT3
10.56-lbs

121W
10.56-lbs

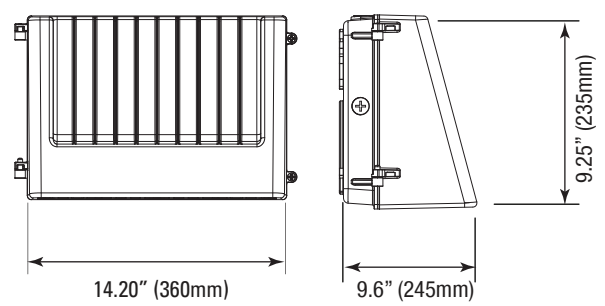

PHOTOMETRICS CHART

39 Watt
DLC Premium

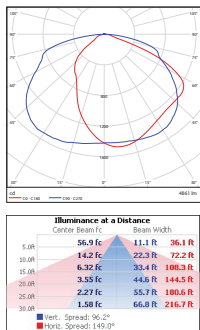

63 Watt
DLC Premium

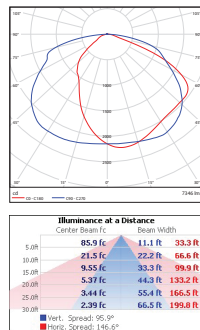

83 Watt
DLC Premium

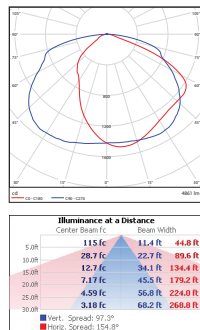

121 Watt
DLC Premium

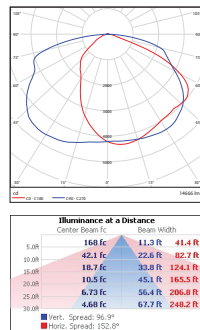

28/40/60 CCT3
DLC Premium

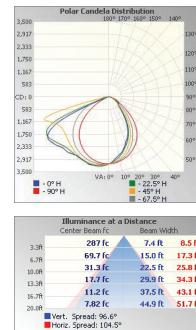

80/100/126 CCT3
DLC Premium

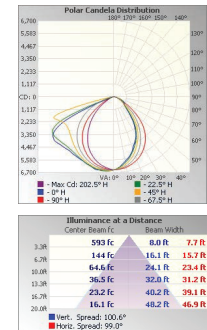

PACKAGE

Case Qty 1 pc

