

HBL HIGHBAY LINEAR Z10

PROJECT: _____

SCHEDULE: _____ DATE: _____

PREPARE BY: _____

NOTES: _____

DESCRIPTION

naturaLED® offers the perfect solution for your lighting needs with our Linear High/Low Bay. This new design allows us to optimize all the beneficial characteristics of LED light in a high-performance fixture that will endure many years of service. These Linear High Bays are extremely durable, yet lightweight, with excellent thermal design. This product is a hybrid crossover, which makes it an excellent fixture for new construction and/or as a replacement solution for your existing High/Low Bays needs. The pre-installed Z10 Receptacle allows easy plug-and-play control upgrades during installation or at a later time.

APPLICATIONS

Warehouses, Parking Garages, Offices, Factories, Hospitals, Hotels

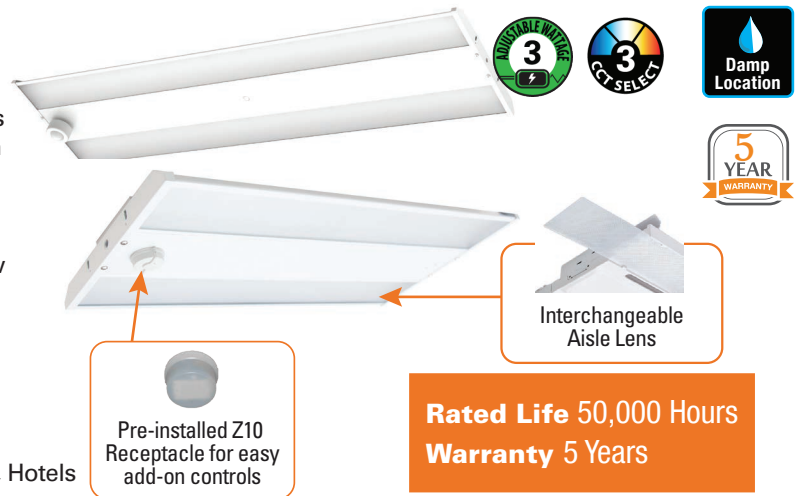

FEATURES

- DLC Premium
- Damp Location
- ETL/cETL Listed
- Wattage & Color Selectable
- Z10 Receptacle Pre-installed
- Wattage: 90-150W, 150-300W
- Color Temp: CCT3 (35/40/50K)
- Voltage: 120-277V, 120-347V, 277-480V
- Surge Protection: 6KV
- Dimmable: 0-10V
- CRI >80
- Operating temperature: - 40°F - 122°F
- Beam Angle: 100°
- Excellent Thermal Design / Select Binning for Consistent Color
- Lens: Minimum Glare w/ Diffused Polycarbonate Lens
- Material: Epoxy Powder Coated
- Available in 12"x22" and 12"x44" configurations
- Warranty: 5 Year Limited
- Optional for purchase: Yoke Mount, Motion Sensor, Emergency Driver, Wire Guard, Surge Protector

ACCESSORIES

	Emergency Driver
	Z10 Receptacle & Controls
	Yoke Mount
	WireGuard
	Remote Controller
	Pendant Mount
	Surge Protector

SAMPLE NUMBER HBL/150S/22FR/8C3-Z10

SERIES	WATTAGE	LENGTH	LENS	CR/COLOR TEMP	RECEPTACLE
HBL	150S	22	FR	8C3	Z10
High Bay Linear	<150 Selectable Wattage	22-inch	Frosted	CRI 80 Selectable Color Temp	Z10 Included



HIGHBAY LINEAR Z10

CEILING & AREA LUMINAIRES

ORDERING

(P=Premium / S=Standard)

Watts (W)	Ordering Code	Description	CCT (K)	Lumens (Lm)	Equiv. Wattage (W)	Voltage	Damp Location	DLC (P/S)
90	9687	HBL/150S/22FR/8C3-Z10	3CCT	12,150	400-575	120-277	•	P
120			(35/40/50K)	16,200				
150				20,250				
150	9688	HBL/300S/44FR/8C3-Z10	3CCT	20,250	575-1000	120-277	•	P
240			(35/40/50K)	32,400				
300				40,500				
90	9689	HBL/150S/22FR/8C3/347-Z10	3CCT	12,150	400-575	120-347	•	P
120			(35/40/50K)	16,200				
150				20,250				
150	9690	HBL/300S/44FR/8C3/347-Z10	3CCT	20,250	575-1000	120-347	•	P
240			(35/40/50K)	32,400				
300				40,500				
90	9703	HBL/150S/22FR/8C3/480-Z10	3CCT	12,150	400-575	277-480	•	P
120			(35/40/50K)	16,200				
150				20,250				
150	9704	HBL/300S/44FR/8C3/480-Z10	3CCT	20,250	575-1000	277-480	•	P
240			(35/40/50K)	32,400				
300				40,500				

ACCESSORIES (Ordered Separately)



Z10 Receptacle (Included)
P10518 REC-Z10-WH
(Z10 receptacle with white cap)



Z10 Sensors
P10520 SEN-ANT-5-Z10-PC
(Z10 Photocell)



P10521 SEN-ANT-5-Z10
(Z10 Microwave Sensor w/Photocell)



P10522 SEN-ANT-6-Z10
(Z10 PIR Sensor w/Photocell)



Remote Programmer
P10316 SEN-BRI-RC100
(Remote Programmer for P10521, P10522)



Yoke Mount
P10092 MT-YK-HBL22
(Yoke Mount for 2-ft Linear High Bay)

P10093 MT-YK-HBL44
(Yoke Mount for 4-ft Linear High Bay)



Aisle Lens
P10599 LENS-HBL22-Aisle
(Aisle Lens for 22" HBL #9687 & 9703)

P10600 LENS-HBL44-Aisle
(Aisle Lens for 44" HBL #9688 & 9704)



Emergency Driver
7341 BAEM20-260BC/347-A
(20W 90-260Vdc LED Emergency Driver 120-347V)



7342 BAEM40-170BC/347-C
(40W Emergency Battery Back up Inverter 120-347V)



Wireguard
P10576 WG-HBL22/WH-G1
(Wireguard for 22" HBL)

P10577 WG-HBL44/WH-G1
(Wireguard for 44" HBL)



Pendant Mount (1/2" & 3/4" NPT)
P10578 ADP-PM-HBL/WH-G1
(1/2" and 3/4" NPT Pendant Mount)



Surge Protector
P10389 SPD-L-10KV-277
(Single Phase Surge Protection 10KV 120-277V)



P10390 SPD-L-20KV-277
(Single Phase Surge Protection 20KV 120-277V)



P10391 SPD-L-20KV-480
(Single Phase Surge Protection 20KV 347-480V)

DIMENSIONS

12" x 22"
5.51-lbs

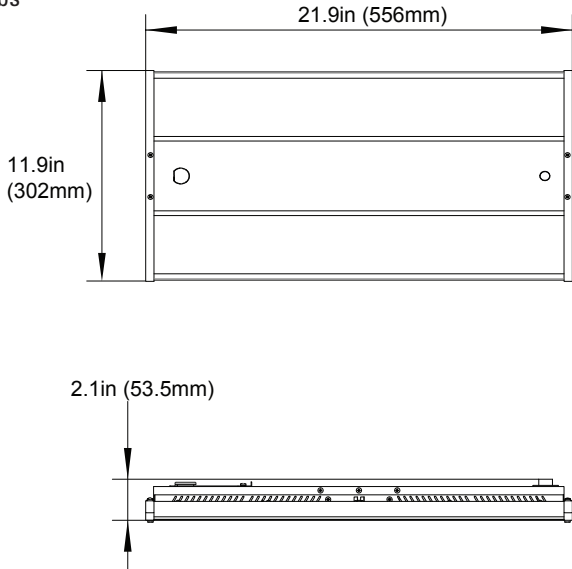

12" x 44"
12.12-lbs

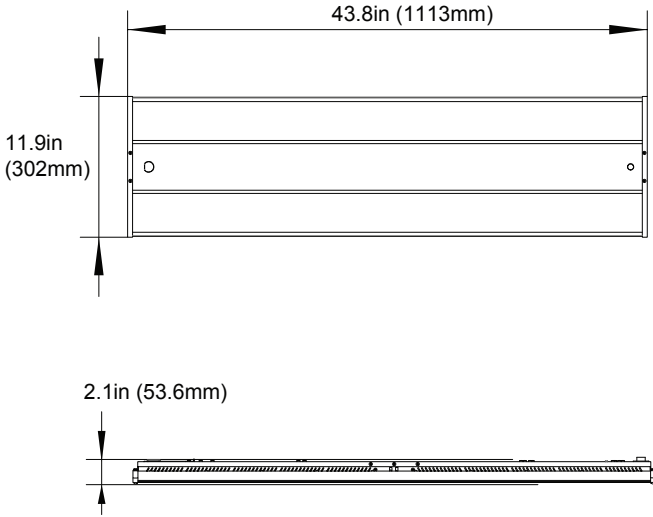

PHOTOMETRICS CHART

12" x 22"

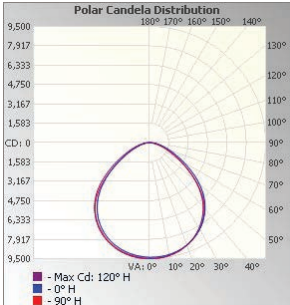

12" x 22" Illuminance at a Distance

Center Beam fc	Beam Width	
3.3R	861 fc	8.3 ft 8.1 ft
6.7R	209 fc	16.8 ft 16.4 ft
10.0R	93.8 fc	25.1 ft 24.5 ft
13.3R	53.0 fc	33.4 ft 32.6 ft
16.7R	33.6 fc	42.0 ft 40.9 ft
20.0R	23.4 fc	50.3 ft 49.0 ft

Vert. Spread: 103.0°
Horiz. Spread: 101.5°

12" x 44"

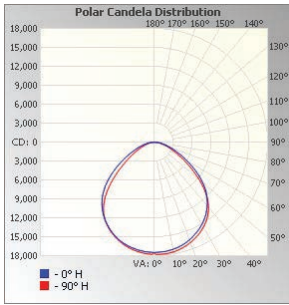

12" x 44" Illuminance at a Distance

Center Beam fc	Beam Width	
3.3R	1,609 fc	8.6 ft 7.7 ft
6.7R	390 fc	17.4 ft 15.6 ft
10.0R	175 fc	26.0 ft 23.3 ft
13.3R	99.1 fc	34.6 ft 31.0 ft
16.7R	62.8 fc	43.4 ft 39.0 ft
20.0R	43.8 fc	52.0 ft 46.7 ft

Vert. Spread: 104.9°
Horiz. Spread: 98.8°

12" x 22" (Aisle Lens)

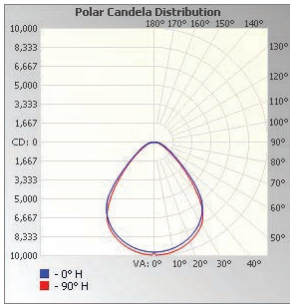

12" x 22" (Aisle Lens) Illuminance at a Distance

Center Beam fc	Beam Width	
3.3R	890 fc	6.4 ft 6.0 ft
6.7R	216 fc	13.0 ft 12.2 ft
10.0R	97.0 fc	19.4 ft 18.2 ft
13.3R	54.8 fc	25.9 ft 24.2 ft
16.7R	34.8 fc	32.5 ft 30.4 ft
20.0R	24.2 fc	38.9 ft 36.5 ft

Vert. Spread: 88.4°
Horiz. Spread: 64.7°

12" x 44" (Aisle Lens)

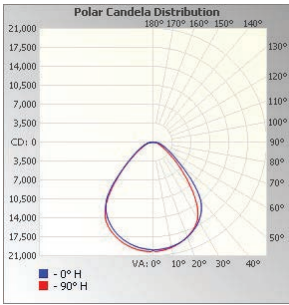

12" x 44" (Aisle Lens) Illuminance at a Distance

Center Beam fc	Beam Width	
3.3R	1,834 fc	6.6 ft 6.0 ft
6.7R	445 fc	13.3 ft 12.2 ft
10.0R	200 fc	19.9 ft 18.3 ft
13.3R	113 fc	26.4 ft 24.3 ft
16.7R	71.6 fc	33.2 ft 30.5 ft
20.0R	49.9 fc	39.7 ft 36.5 ft

Vert. Spread: 89.6°
Horiz. Spread: 64.8°

PACKAGE

Case Qty 2 pcs per pack

