

SCM SLIM CANOPY 10"x10"

DESCRIPTION

naturaLED® SCM IP65 rated fixtures come in an aesthetically pleasing construction, low-profile design with die-cast aluminum housing and shatter-resistant polycarbonate prismatic lens. In addition, they are dust-proof and include 1/2" threaded conduit entrances on each side. The SCM fixtures are available with or without a microwave occupancy sensor mounted behind the lens. This sensor has multiple settings that can be selected via a dip switch. The settings on the sensor include: step dimming, area sensitivity, standby time and on/off. The SCM supports both pendant mounting and direct surface mounting ceiling or wall. Pendant mounting accepts a 3/4" NPT thread and can be mounted to multiple types of J-boxes.

APPLICATIONS

Warehouses, Parking Garages, Offices, Factories, Hospitals, Hotels

FEATURES

- DLC Premium Qualified
- IP65 Rated
- ETL Listed
- Long life LED chips
- ColorTemp: 4000K, 5000K
- Dimmable: 1-10V
- Input line voltage: 120-277V
- CRI: 80
- Powerfactor >0.9
- Surge Protection: 4KV
- Beam Angle: 160°
- Emergency driver compatible as optional accessories
- Material: aluminum die-cast
- Operating temperature: - 40°F - 122°F
- 5 Year Warranty
- Finish: Black /White

PROJECT:

SCHEDULE:

DATE:

PREPARE BY:

NOTES:



Rated Life 50,000 Hours
Warranty 5 Years

ACCESSORIES

	Emergency Driver
	Motion Sensor
	Beauty Plate
	Drop Lens
	Frosted Lens
	Surge Protector
	Photocell

SAMPLE NUMBER FX10SCM28/840/BK-SEN

FAMILY	SIZE	SERIES	WATTAGE	CRI/COLOR TEMP	COLOR	ACCESSORY
FX	10	SCM	28	840	BK	SEN
Fixture	10-inch	Slim Canopy	28 Watt	CRI 80 4000K	Black (WH) White	Motion Sensor none N/A



SLIM CANOPY 10X10

CEILING & AREA LUMINAIRES

ORDERING

*P= Premium DLC / *S = Standard DLC

	Watts (W)	Ordering Code	Description	CCT (K)	Lumens (Lm)	Equiv. Wattage (W)	Dim (V)	Color	Sensor	IP65 Rated	DLC (S/P)
Motion Sensor	28	9432	FX10SCM28/840/BK-SEN	4000K	3,640	150	1-10V	Black	•	•	P
	28	9433	FX10SCM28/850/BK-SEN	5000K	3,640	150	1-10V	Black	•	•	P
	42	9434	FX10SCM42/840/BK-SEN	4000K	5,517	175	1-10V	Black	•	•	P
	42	9435	FX10SCM42/850/BK-SEN	5000K	5,638	175	1-10V	Black	•	•	P
	59	9436	FX10SCM59/840/BK-SEN	4000K	7,695	250	1-10V	Black	•	•	P
	59	9437	FX10SCM59/850/BK-SEN	5000K	7,845	250	1-10V	Black	•	•	P
	28	9414	FX10SCM28/840/BK	4000K	3,640	150	1-10V	Black	-	•	P
	28	9415	FX10SCM28/850/BK	5000K	3,640	150	1-10V	Black	-	•	P
	42	9418	FX10SCM42/840/BK	4000K	5,517	175	1-10V	Black	-	•	P
	42	9419	FX10SCM42/850/BK	5000K	5,638	175	1-10V	Black	-	•	P
	59	9422	FX10SCM59/840/BK	4000K	7,695	250	1-10V	Black	-	•	P
	59	9423	FX10SCM59/850/BK	5000K	7,845	250	1-10V	Black	-	•	P
	28	9416	FX10SCM28/840/WH	4000K	3,640	150	1-10V	White	-	•	P
	28	9417	FX10SCM28/850/WH	5000K	3,640	150	1-10V	White	-	•	P
	42	9420	FX10SCM42/840/WH	4000K	5,517	175	1-10V	White	-	•	P
	42	9421	FX10SCM42/850/WH	5000K	5,638	175	1-10V	White	-	•	P
	59	9424	FX10SCM59/840/WH	4000K	7,695	250	1-10V	White	-	•	P
	59	9425	FX10SCM59/850/WH	5000K	7,845	250	1-10V	White	-	•	P

ACCESSORIES (Ordered Separately)

Motion Sensor



P10234 SEN-MC605V-D
(Microwave Motion Sensor 0-10V)

Emergency Driver



7336 BAEM4-60BC/MV-A
(Emergency Driver for 28W & 42W)

Photocell



P10036 SEN-PHO-BT-MT/MV
(Button Photocell 120V-277)

Beauty Plates



P10195 PLT-SCM/14X14/WH
(14"x14" Beauty Plate used with SCM)

P10196 PLT-SCM/24X24/WH
(24"x24" Beauty Plate used with SCM)

Frosted Lens



P10125 LENS-SCM/FR9X9
(Frosted Lens for SCM 28W, 42W, 59W)

Drop Lens



P10126 LENS-SCM/DR9X9
(Drop Lens for SCM 28W, 42W, 59W)

Surge Protector



P10389 SPD-L-10KV-277
(Surge Protection 10KV 120-277V)



P10390 SPD-L-20KV-277
(Surge Protection 20KV 120-277V)



P10391 SPD-L-20KV-480
(Surge Protection 20KV 347-480V)

DIMENSIONS

28W **42W** **59W**
4.50-lbs 5.10-lbs 5.10-lbs

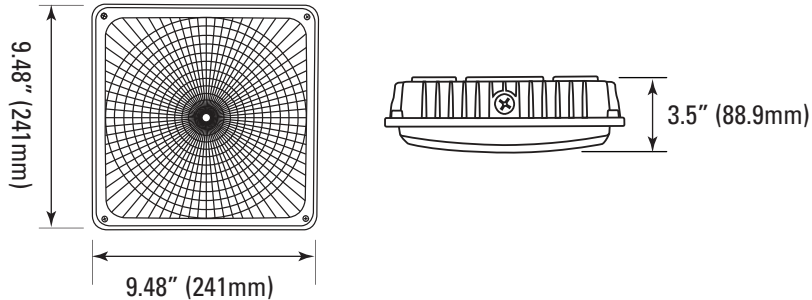

PHOTOMETRICS CHART

28 Watt
DLC Premium

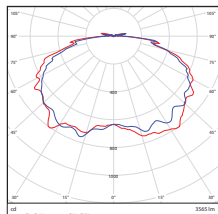

Distance	Center Beam fc	Beam Width
2.5R	101 fc	16.6 R
5.0R	25.3 fc	33.1 R
7.5R	11.3 fc	49.7 R
10.0R	6.34 fc	66.3 R
12.5R	4.06 fc	82.8 R
15.0R	2.82 fc	99.4 R

Vert. Spread: 146.4°
Horiz. Spread: 142.7°

42 Watt
DLC Premium

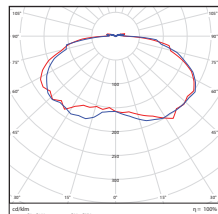

Distance	Center Beam fc	Beam Width
2.5R	140 fc	25.6 R
5.0R	34.9 fc	51.2 R
7.5R	15.5 fc	76.9 R
10.0R	8.72 fc	102.5 R
12.5R	5.58 fc	128.1 R
15.0R	3.88 fc	153.7 R

Vert. Spread: 157.9°
Horiz. Spread: 151.6°

59 Watt
DLC Premium

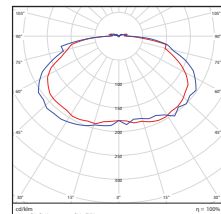

Distance	Center Beam fc	Beam Width
2.5R	219 fc	20.9 R
5.0R	54.6 fc	41.8 R
7.5R	24.3 fc	62.7 R
10.0R	13.1 fc	83.5 R
12.5R	8.74 fc	104.4 R
15.0R	6.07 fc	125.3 R

Vert. Spread: 153.1°
Horiz. Spread: 156.9°

28 Watt with sensor
DLC Premium

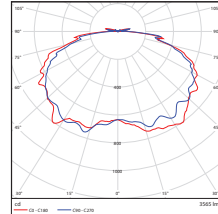

Distance	Center Beam fc	Beam Width
2.5R	101 fc	16.4 R
5.0R	25.3 fc	33.7 R
7.5R	11.3 fc	49.7 R
10.0R	6.34 fc	66.3 R
12.5R	4.06 fc	82.8 R
15.0R	2.82 fc	99.4 R

Vert. Spread: 146.4°
Horiz. Spread: 142.7°

42 Watt with sensor
DLC Premium

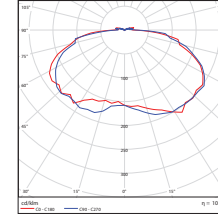

Distance	Center Beam fc	Beam Width
2.5R	140 fc	25.2 R
5.0R	34.9 fc	51.2 R
7.5R	15.5 fc	76.9 R
10.0R	8.72 fc	102.5 R
12.5R	5.58 fc	128.1 R
15.0R	3.88 fc	153.7 R

Vert. Spread: 157.9°
Horiz. Spread: 151.6°

59 Watt with sensor
DLC Premium

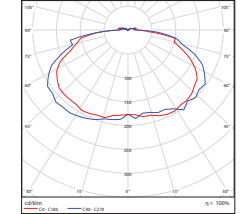

Distance	Center Beam fc	Beam Width
2.5R	219 fc	20.9 R
5.0R	54.6 fc	41.8 R
7.5R	24.3 fc	62.7 R
10.0R	13.7 fc	83.5 R
12.5R	8.74 fc	104.4 R
15.0R	6.07 fc	125.3 R

Vert. Spread: 153.1°
Horiz. Spread: 156.9°

PACKAGE

Case Qty 1 pc

